

## MOBILZAUNADAPTER F. CITYBLOC® UND BETONLEITWÄNDE

MOBILZAUNADAPTER						
Artikelnr.	Bezeichnung		Ausf.	ca. kg	Maße	M
200249	Mobilzaunadapter	f. CITYBLOC	verzinkt	5,40		M
102043	Mobilzaunadapter	f. Betonleitwand 15/80	verzinkt	5,90		
200248	Mobilzaunadapter	f. Betonleitwand 13/80	verzinkt	5,40		
204558	Mobilzaunadapter m. Versatz	f. Betonleitwand 15/80	verzinkt	9,90		

**M** = EKRO MIETPARK

Anwendungsbeispiel  
Mobilzaunadapter inkl. Citybloc

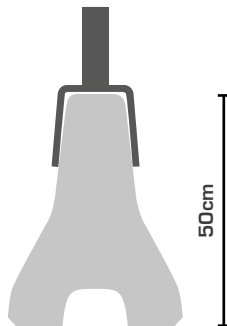

200249

Anwendungsbeispiele  
Mobilzaunadapter inkl. Betonleitwand

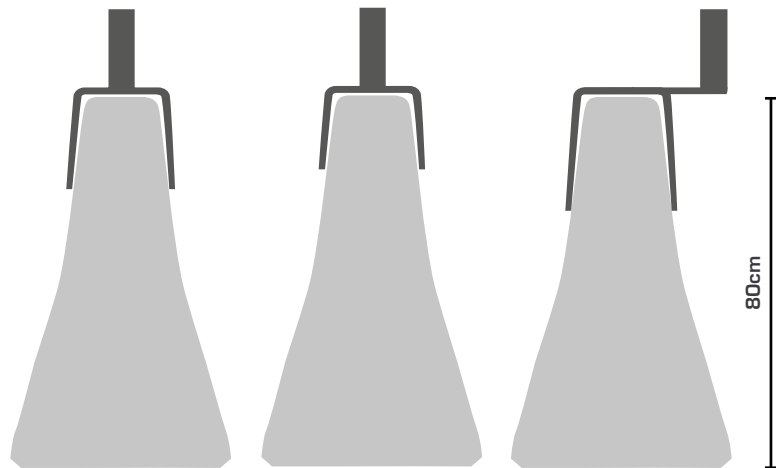

102043

200248

204558

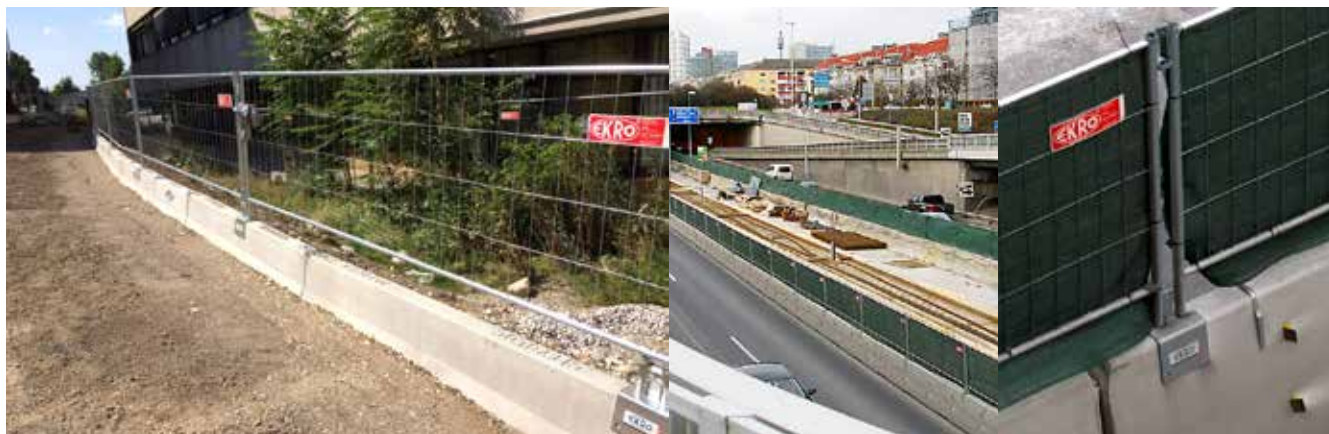

Für Satz- und Druckfehler wird keine Haftung übernommen. Technische Änderungen vorbehalten. © EKRO Bausystem GmbH

EKRO Bausystem GmbH

Zentrale Krieglach  
Lastenstraße 13, 8670 Krieglach, Austria  
☎ +43 3855 2631  
✉ zentrale@ekro.at

www.ekro.at

Niederlassung Wien  
Doerenkampgasse 9, 1100 Wien, Austria  
☎ +43 1 6887631  
✉ zentrale@ekro.at



# PRODUKTINFORMATION

EKRO® Mobilzaunadapter



GEMEINSAM SICHER NACH OBEN®



200249

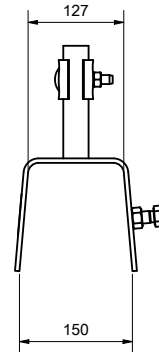
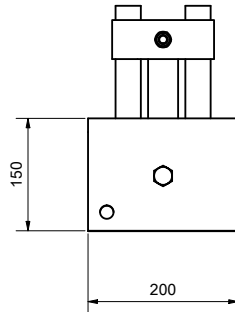

102043

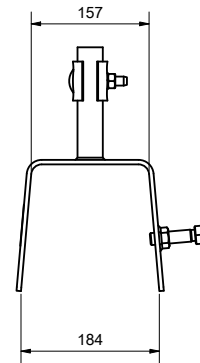
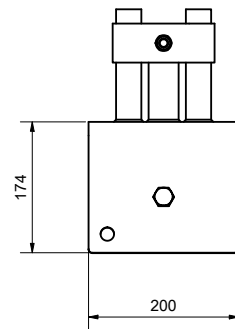

200248

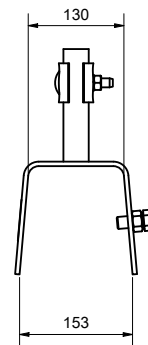
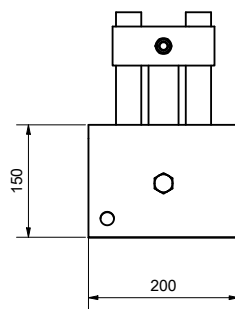

204558

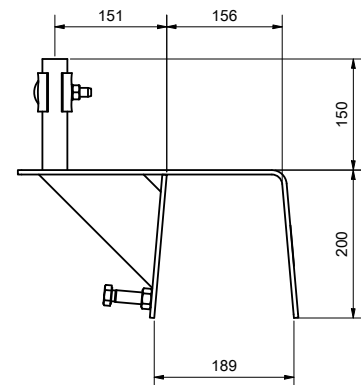
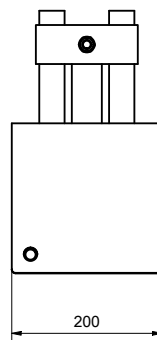

Für Satz- und Druckfehler wird keine Haftung übernommen. Technische Änderungen vorbehalten. © EKRO Bausystem GmbH

EKRO Bausystem GmbH

[www.ekro.at](http://www.ekro.at)

Zentrale Krieglach  
Lastenstraße 13, 8670 Krieglach, Austria  
☎ +43 3855 2631  
✉ [zentrale@ekro.at](mailto:zentrale@ekro.at)

Niederlassung Wien  
Doerenkampgasse 9, 1100 Wien, Austria  
☎ +43 1 6887631  
✉ [zentrale@ekro.at](mailto:zentrale@ekro.at)

